

عناصر التصميم المعماري

(REGULAR & IRREGULAR FORMS) الأشكال المنتظمة وغير المنتظمة

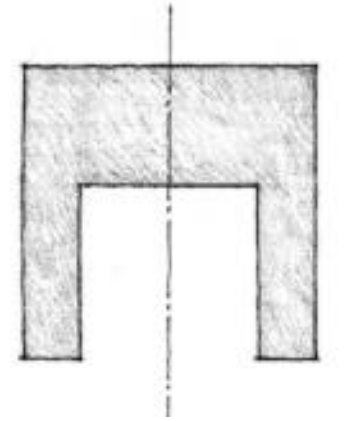
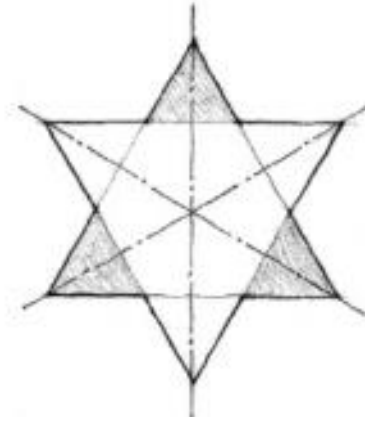
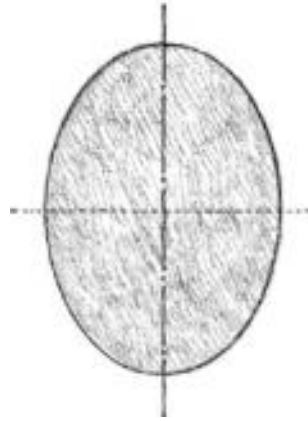
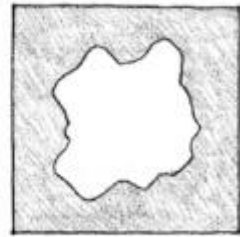
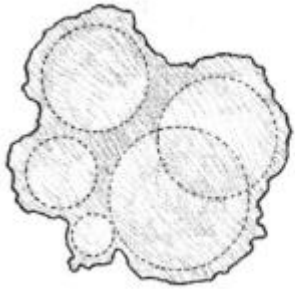
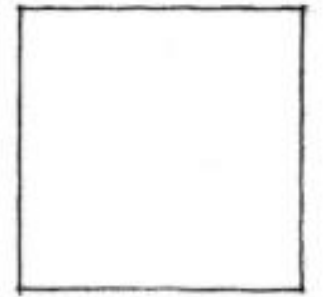
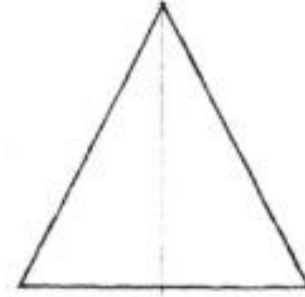
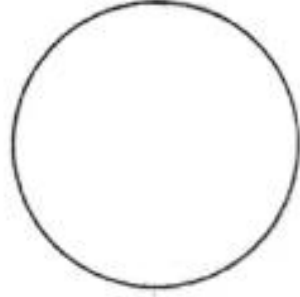
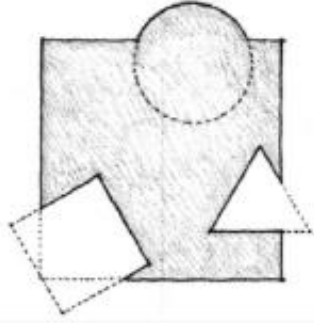
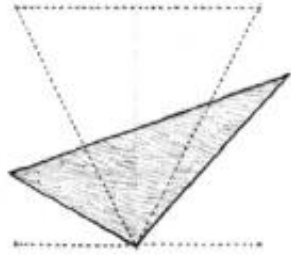
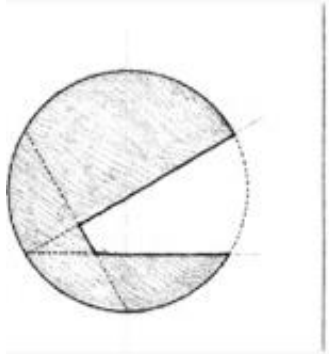

عناصر التصميم المعماري

(REGULAR & IRREGULAR FORMS) الأشكال المنتظمة وغير المنتظمة

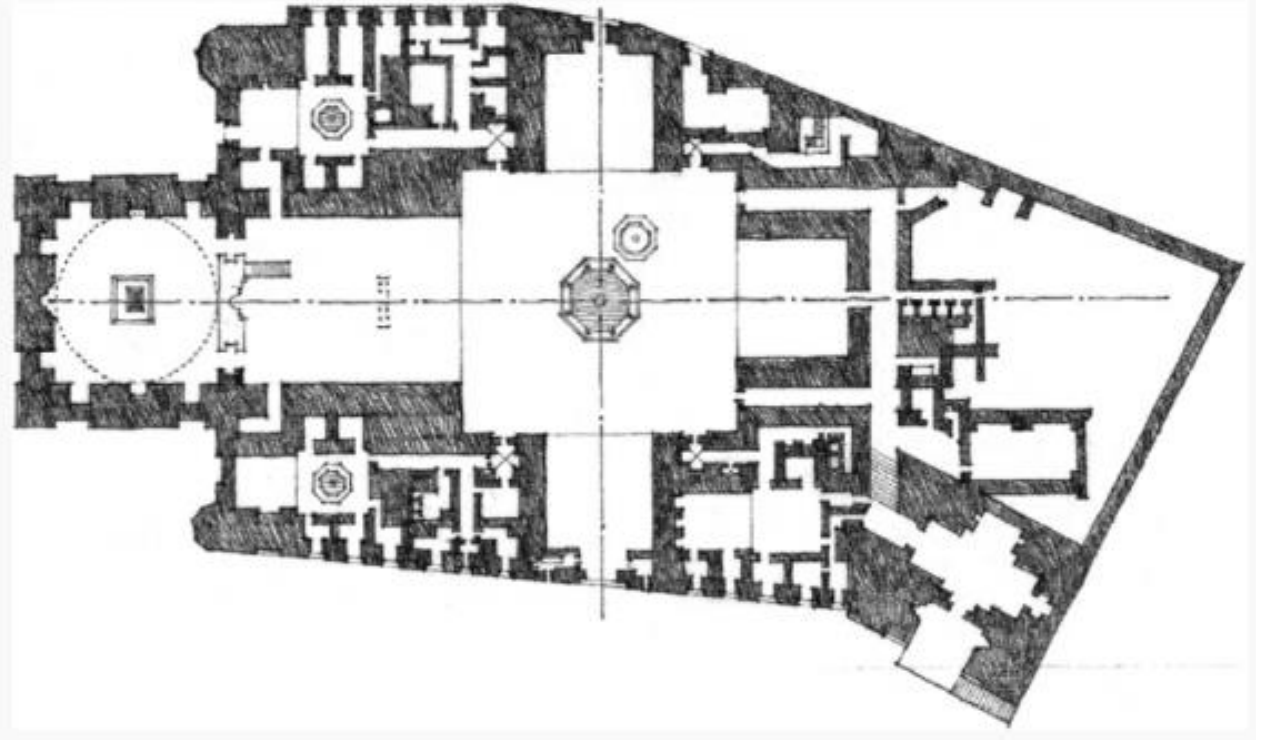
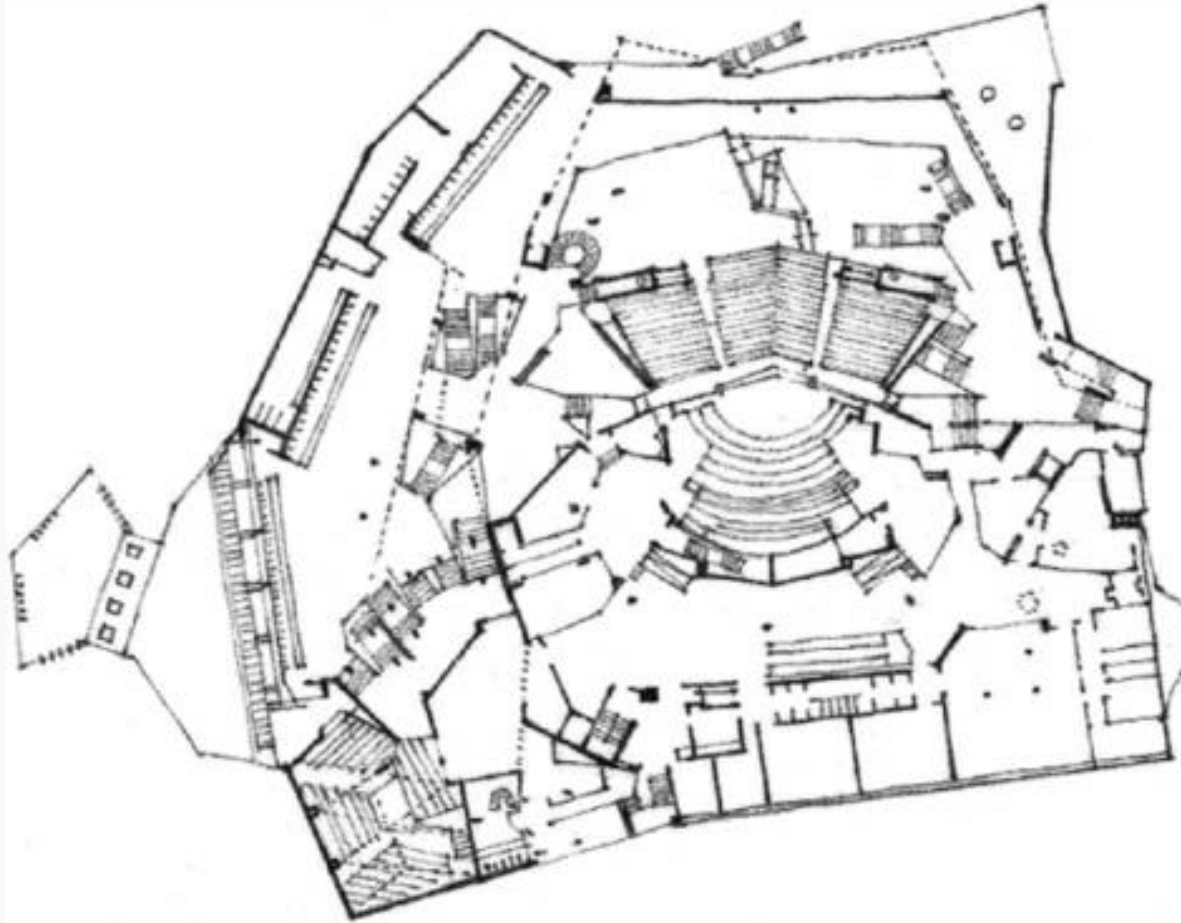

التشكيل المعماري

تحول الكتلة (TRANSFORMATION OF FORM)

التحول البعدي (Dimensional Transformation)

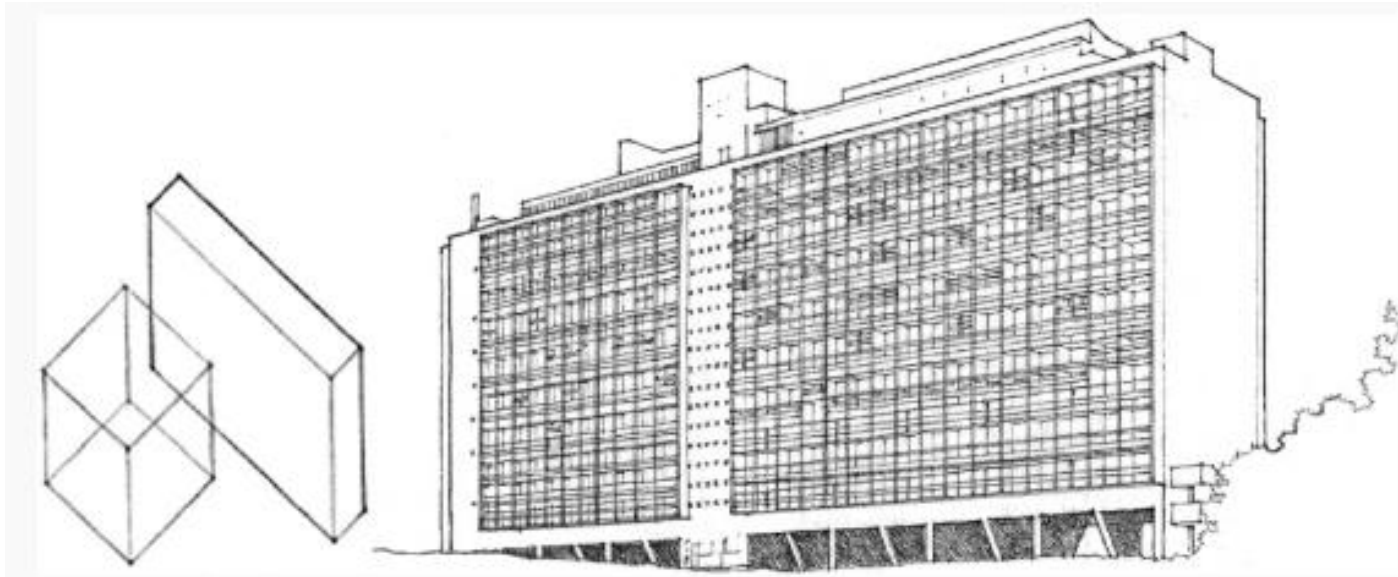
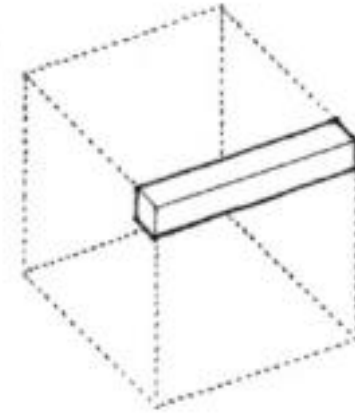
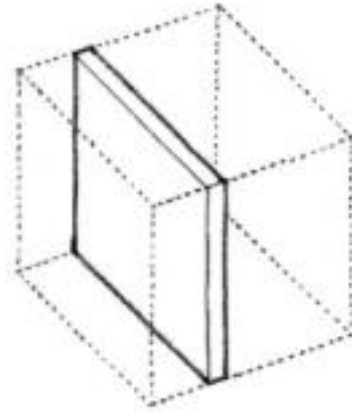
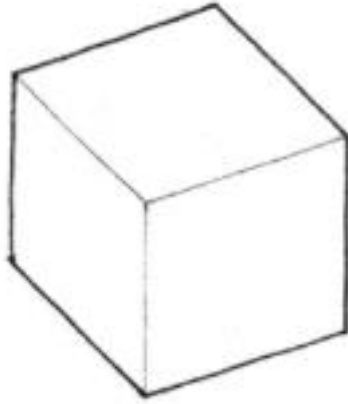

التشكيل المعماري

تحول الكتلة (TRANSFORMATION OF FORM)

التحول البعدي (Dimensional Transformation)

